

GULLBERG *GJ* JANSSON

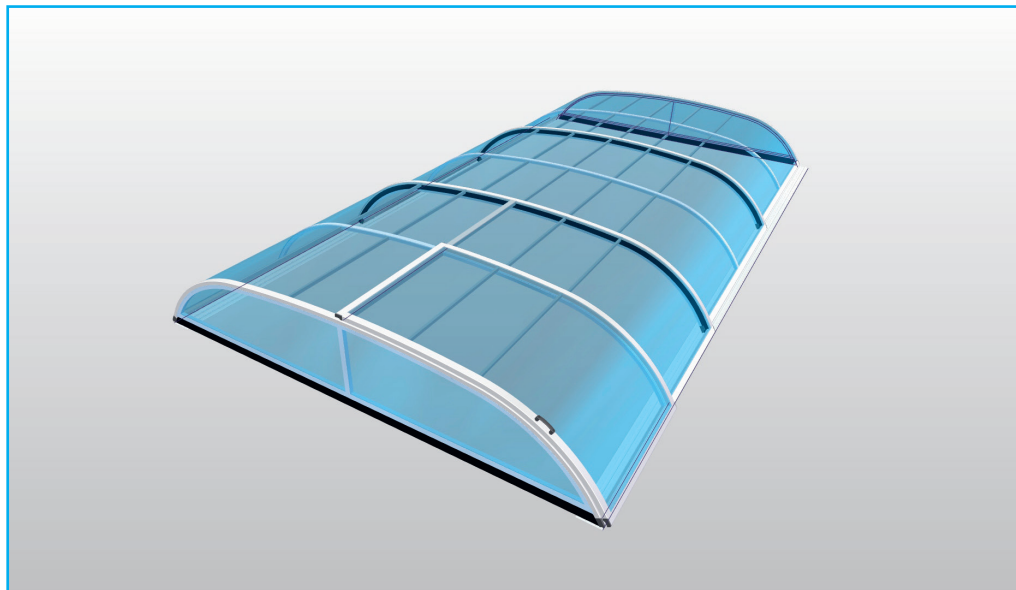

P O O L T A K

NOVA COMFORT

3x6 utan sarg

II. Modellspecifik monteringsmanual

Rev 2022.1 A3M

Lista över smådelar

Nr	Namn	Art.nr
1	4,8x50 kullrig skruv	71300
2a	Sektionslåsning skena comfort	71349
2b	4,2x10 kullrig skruv	71385
3	Popnit 12mm (aluminium/antracit)	71302/7131001
4a	Cylinderlås Comfort	71372
4b	Cylinderlås Comfort bricka	71372
4c	Cylinderlås Comfort plugg	71373
5	6x60 kullrig skruv	71364
6	Plugg* för kullrig skruv	71365
7a	Handtag insida	71320
7b	4,8x25 kullrig skruv	71327
7c	Bricka 6,5x12	71363
7d	Täcklock handtag insida	71321
8a-b	Handtag skjutdörr, Bricka	7131114/71363
8c-d	Kullrig skruv, Lock	71300/7131116
8e-f	Täckbricka, Lock	7131113/15
9	Ändstycke Comfort H/V	71340/41
10a	Manuell låsning Comfort V/H	71376/77
10b	M6 mutter	71382
10c	Bricka 6,5x12	71363
10d	M6x8 kullrig skruv	71379
10e	M6x35 kullrig skruv	71378
10f	Låspinne sektionlåsning Comfort	71370
11	Ändstycke med hål Comfort H/V	71338/39
12a	Öppnare automatisk låsning Comfort	71375
12b	M6x35 kullrig skruv	71378
12c	M6 mutter	71382
12d	Hylsa automatisk låsning Comfort	71374
13	Markhylsa gaveldörr	71312
14a	Skensprint Comfort	71371
14b	Ändstycke skena Comfort H/V	71347/48
14c	Stoppbit skena Comfort	71381
14d	6x60 kullrig skruv	71364
14e	Plugg till 6x60 kullrig skruv	71365
15	Lås skjutdörr	71331
15b	Nyckel skjutdörr	71310
16	Låsbar mutter gavel	71325
16b	Mutter gavel	71324
17	Stoppbit skjutdörr	71317
17b	4,8x22 försänkt skruv	71326
17c	Plugg grå 9,5mm (grå/antracit)	71315/7131002
18	Låsbeslag H/V	71358/57
18b	M6x20 kullrig skruv	71380
19	Sektionstätning A+B+BC Gummitätning dörr Nova A+B	71322/62
20	Sektionstätning A+B+BC Sektionstätning C	71322/34
21	Tätning A+B skjutdörr	71329
22	Paneltätning - dubbel (endast för klar panel)	71323

* Behövs ej vid montering i trä

Översikt - Nova Comfort utan sarg

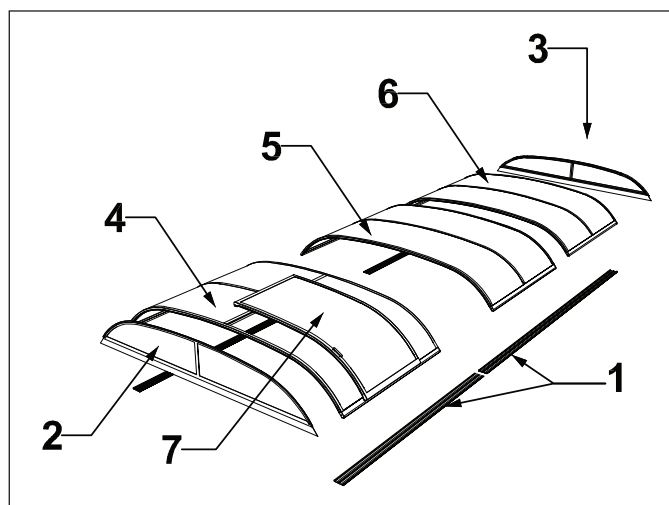

Lista över delar - Nova Comfort utan sarg

Nr	Beskrivning	Antal	Avsnitt i allmän monteringsmanual
1	Skenor	4	2
2	Frontgavel	1	8
3	Bakgavel	1	8
4	Största sektionen	1	3
5	Andra sektionen	1	4
6	Tredje sektionen	1	4
7	Skjutdörr	1	6

Dimensioner - Nova Comfort utan sarg

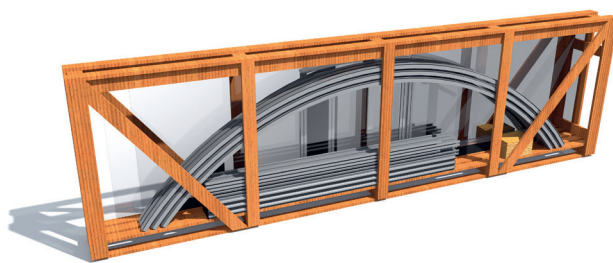











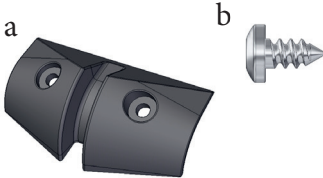

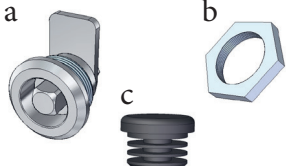
Namn	Modell		Fraktmått			Vikt kg
	Typ	Panel	Längd	Höjd	Djup	
Nova 3x6	A3M	Kanal*	4200	1350	410	220
Nova 3x6	A3M	Klar**	4200	1350	410	250

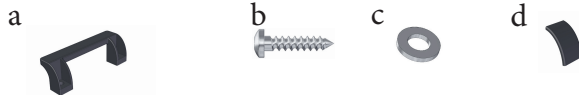
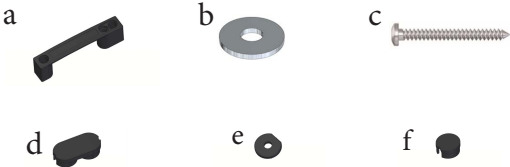
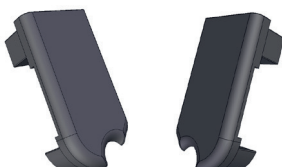
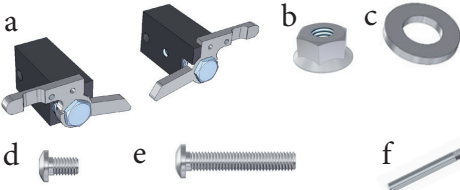
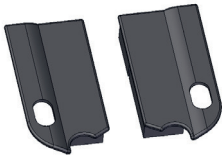
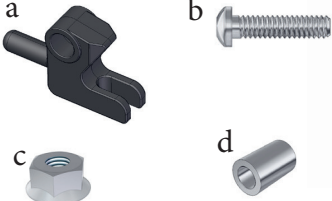

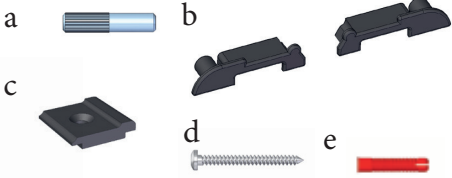
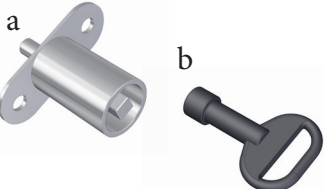

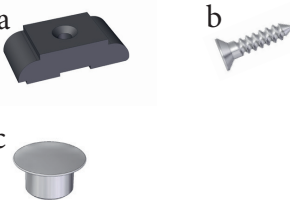
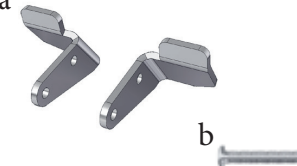

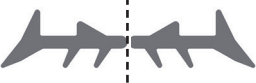

*Kanal: Dubbelsidig kanalplast polykarbonat

**Klar: Klar polykarbonat

OBS! Vi rekommenderar att ni tar av skyddsplasten på panelerna innan montering!

Bildregister över smådelar

1	4,8x50 kullrig skruv	2	Sektionslåsning	3	Popnit	4	Cylinderlås
							
5	6x60 kullrig skruv	6	Plugg	7 Handtag insida			
							
8 Handtag skjutdörr		9 Ändstycke V/H		10 Manuell låsning			
							
11	Ändstycke med hål	12	Öppnare aut.låsning	13	Markhylsa	14 Skensprint, Ändstycke, Stoppbit	
							
15	Lås skjutdörr	16	Låsbar mutter	17	Stoppbit skjutdörr	18 Låsbeslag H/V	
							
19	Sektions o dörrtätning	20	Sektionstätning	21	Tätning A+B Skjutdörr	22 Paneltätning**	
							

	T2  4,1mm	T3  3,5mm	T4  7mm	T5  TRX25	T6  TRX20	T7 	T8 	T9 
---	--	--	--	--	---	---	---	---

2 SKENINSTALLATION - Nova 3x6 utan sarg

Skenans placering

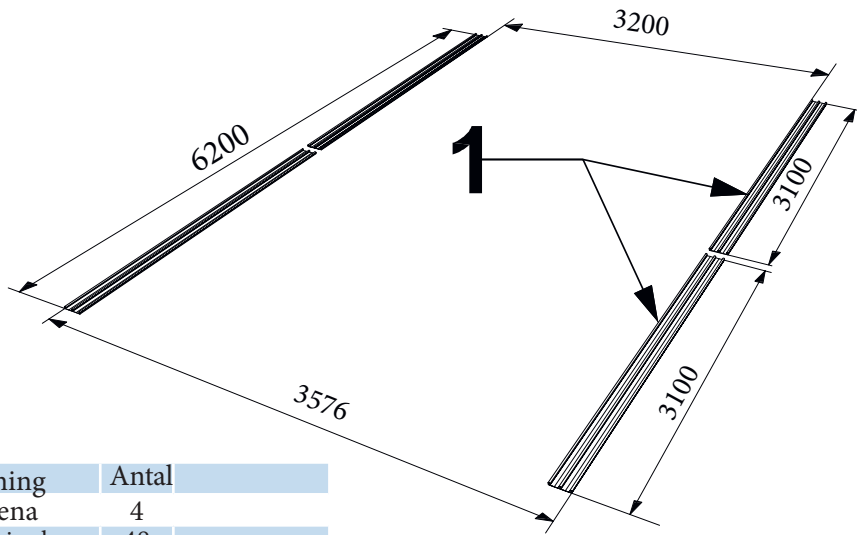

Nr	Beskrivning	Antal
1	Skena	4
5	6x60 kullrig skruv	48
6	Plugg *	
14a	Skensprint	6

*Plugg behövs ej vid installation i trätrall

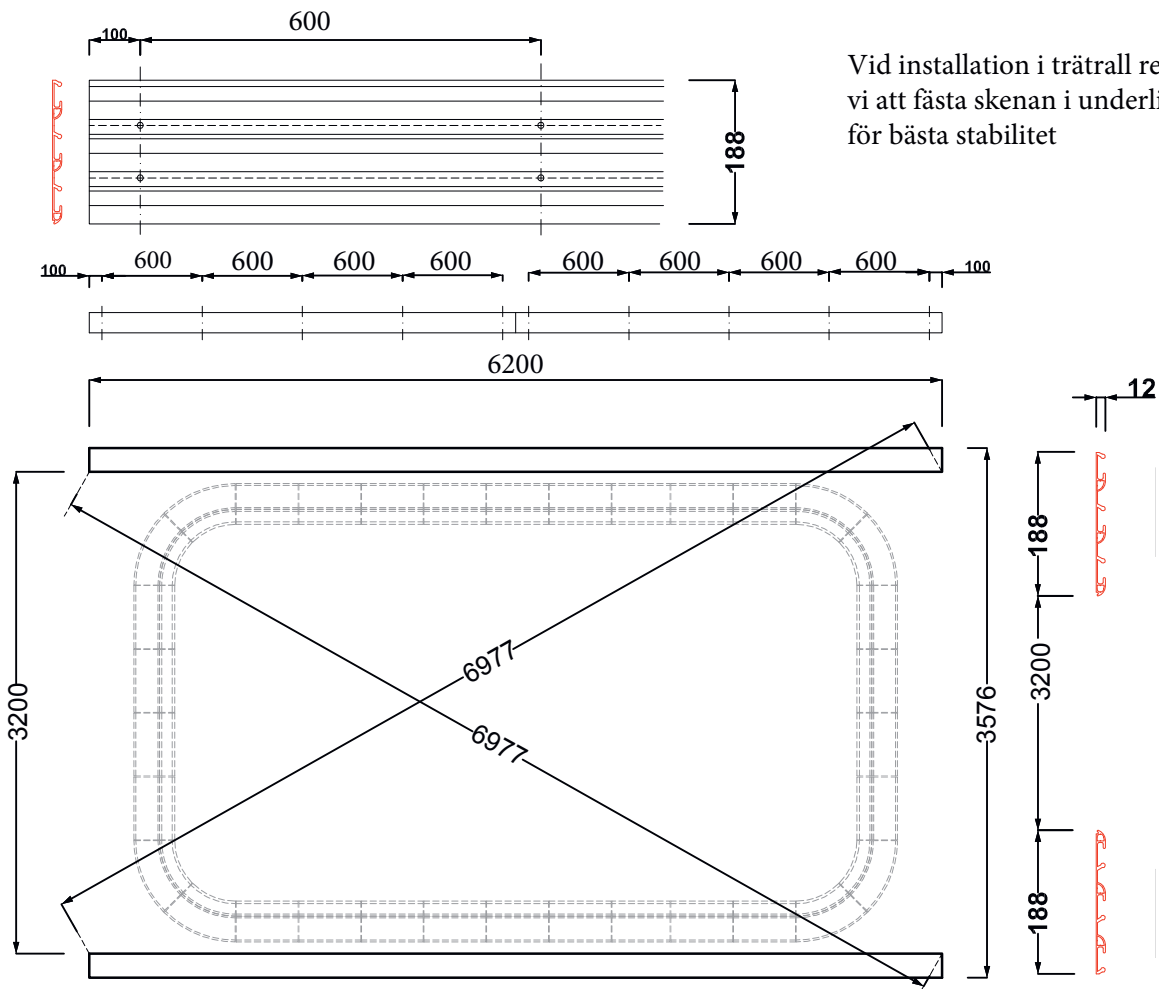

3 MONTERING STÖRSTA SEKTIONEN

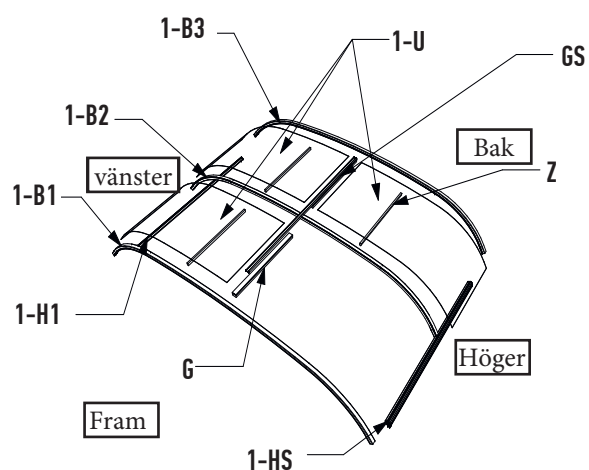

Med skjutdörr på vänster sida

Med skjutdörr på höger sida

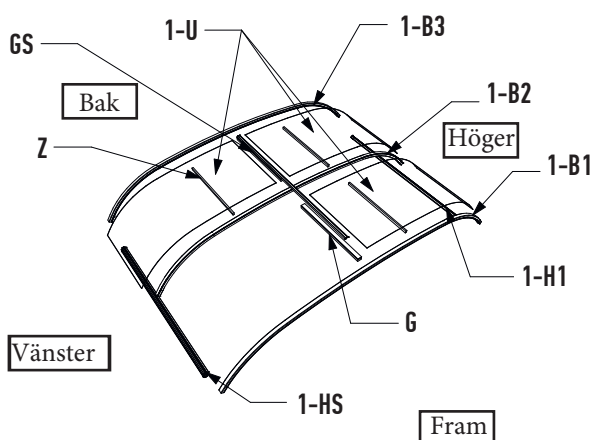

Nr	Beskrivning	Antal	Notering
1-B1	Bågprofil (främre)	1	
1-B2	Bågprofil (mitten)	1	
1-B3	Bågprofil (bakre)	1	
1-H1	Horisontell profil	1	
1-HS	Horisontell profil med spår	1	
1-U	PC klar panel/PC Kanalplast	3	
Z	Z Profil tvärstag	3	
G	G Profil mittstag	1	
GS	Mittstag dörrskena	1	
1	Kullrig skruv	12	4,8x50
4	Cylinderlås Comfort	1	
9	Ändstycke H/V	2	1st höger 1 st vänster
10	Manuell låsning H/V	2	1st höger 1 st vänster
18	Låsbeslag H/V	2	1st höger 1st vänster
22	Paneltätning * dubbel		

* endast med PC klar panel

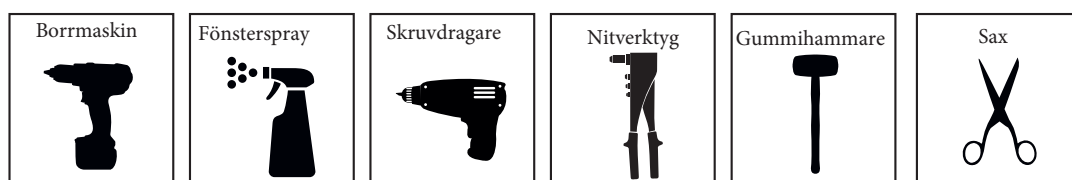

4 MONTERING MELLAN SEKTIONEN

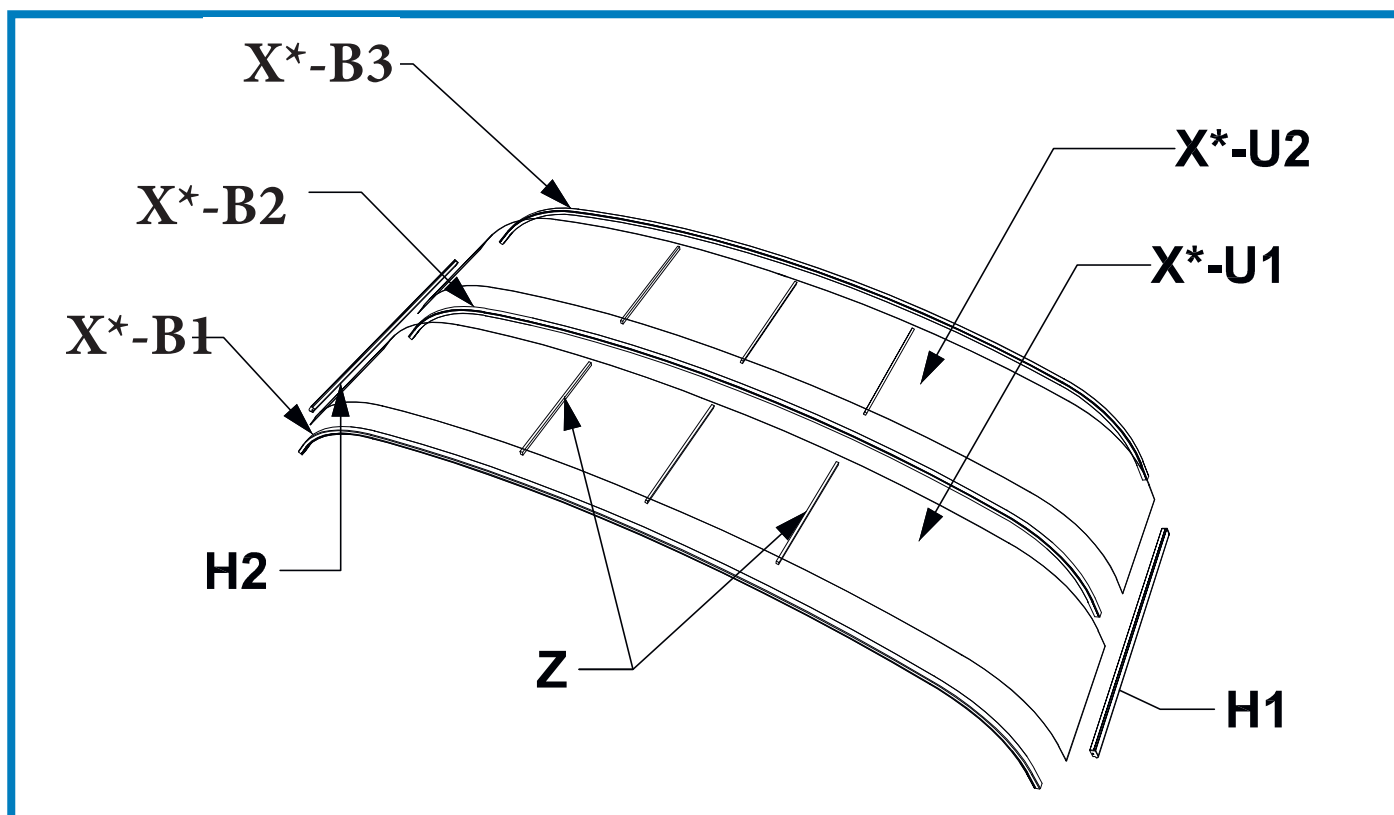

Nr	Beskrivning	Antal	Notering
X*-B1	Bågprofil (främre)	1	
X*-B2	Bågprofil (mitten)	1	
X*-B3	Bågprofil (bakre)	1	
H1	Horisontell profil - höger	1	
H2	Horisontell profil - vänster	1	
X*-U1	PC klar panel/PC kanalplast	1	
X*-U2	PC klar panel/PC kanalplast	1	
Z	Z profil tvärstag	6	
1	Kullrig skruv	12	4,8 x 50
12	Öppnare automatisk låsning	1	1
18	Låsbeslag H/V	2	1st höger 1st vänster
9	Ändstycke Comfort H/V	2	1st höger 1st vänster
11	Ändstycke med hål H/V	2	1st höger 1st vänster
22	Paneltätning Dubbel **		

X* = Antal sektioner

** endast med PC klar panel

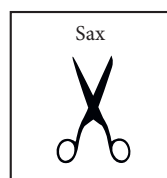

6 MONTERING SKJUTDÖRR

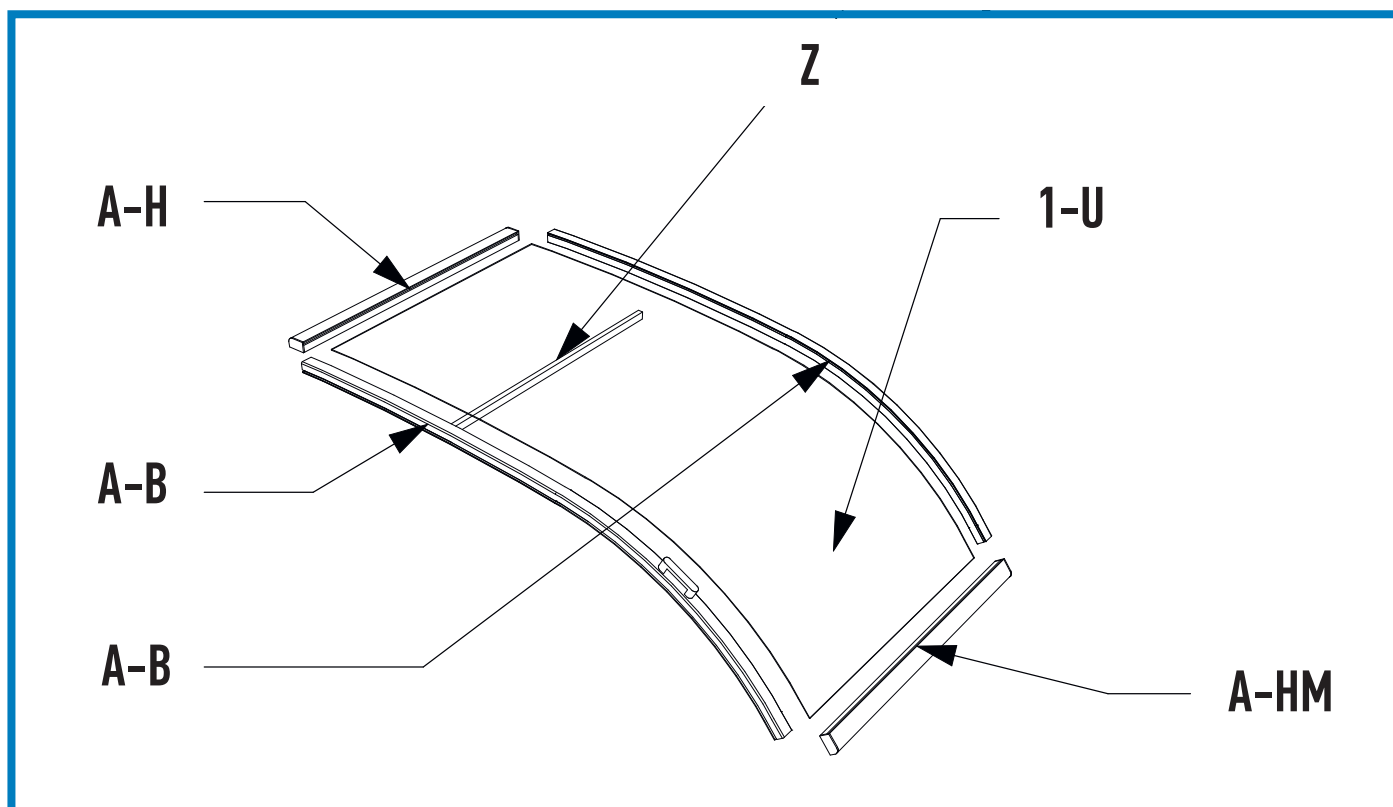

Nr	Beskrivning	Antal	
A-B	Bågprofil (främre)	1	
A-B	Bågprofil (bakre)	1	
A-H	Horisontell profil (undre)	1	
A-HM	Horisontell profil (undre)	1	
1-U	PC klarpanel/PC kanalplast	1	
Z	Z profil tvärstag	1	
1	Kullrig skruv	8	
15a	Lås skjutdörr	1	
17	Stoppbit skjutdörr	8	
21	Tätning A+B skjutdörr	1	
22	Paneltätning dubbel *		

*endast med PC klar panel

10 SLUTMONTERING

Nr	Beskrivning	Antal	Notering
14c	Stoppbit skena	4	
14b	Ändstycke skena	6	3st vänster 3st höger
13	Markhylsa	2	

